



RUTLAND COUNTY
GARDEN FURNITURE

Hand-Crafted

ASSEMBLY INSTRUCTIONS

RUTLAND PANEL PERGOLA

Before you commence the assembly process, we recommend that you read these instructions thoroughly beforehand to familiarise yourself with the assembly process and to also check that you have the correct components. If for any reason you need assistance, you can find our contact details on the final page of these instructions.

We strongly recommend that any assembly is carried out on an open flat, level surface if possible and with sufficient space. You will also require the assistance of at least 2 adults to complete assembly safely.

If for any reason you don't feel confident in completing this project, we would recommend consulting a qualified professional to undertake the work.

Tools required:







10mm socket, No2 Pozidriv screwdriver (or electric driver), step ladder or platform.

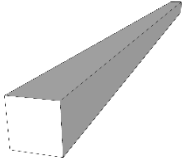
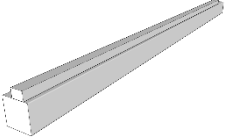
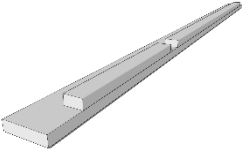
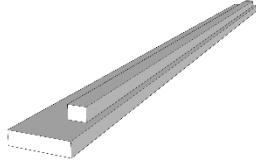
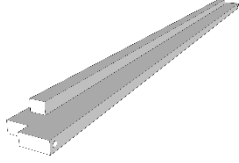
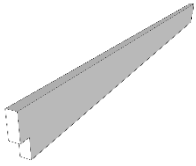

THE RUTLAND PANEL PERGOLA

RUTLAND PANEL PERGOLA

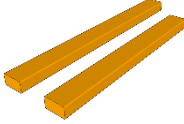
Components list

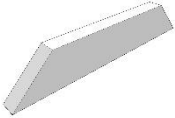
50mm Woodscrews	60mm Woodscrews	120mm Coachscrews	2 x Plain Posts	4 x Battened Posts
				
2 x Runner	2 x Outer rafter	2 x Inner Rafter	Centre rafter(s)	Roof lattice strips (long)
				
Upright lattice strips (short)	2 x Spacer bars	70mm Coach Screws	Braces (optional)	
				

Please note: The posts are supplied at 2.7M in length so that you can trim them down as required (typically to 2.1M) or accommodate a slope for example. Resize the battened posts by cutting through the end with batten attached (always leave the 140mm batten free section intact) before commencing assembly.

RUTLAND PANEL PERGOLA

Step 1

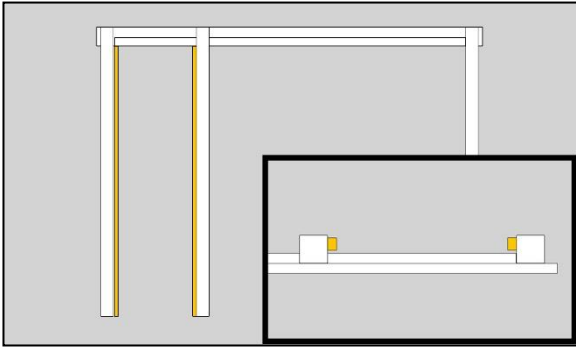

Before commencing assembly take a moment to familiarise yourself with the post arrangement along each runner. The end of the runner with the intermediate slot will house the two battened posts (battens facing each other). Note also how the batten extends to the floor and how the battens are furthest from the outer face of the runner.

Step 2

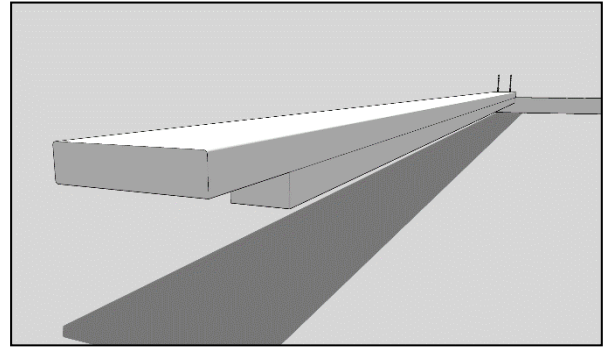

Begin by laying one of the posts down on a flat, level surface and then placing one of the runners with its batten side down and orientated toward the length of the post, on top of it...

Step 3

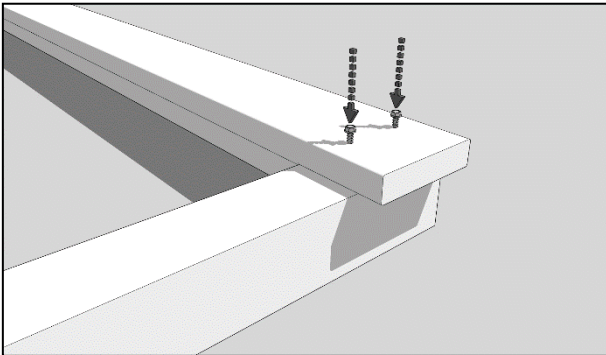

...with the batten butted up against the post and the top of the post flush with the top edge of the runner. Now fix into place using 2 of the 70mm coachscrews.

Step 4

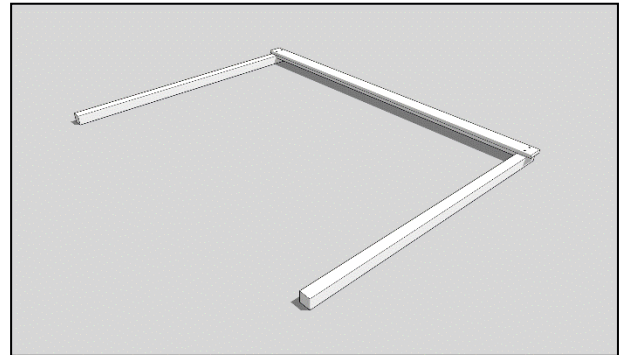

Add another post to the other end of the runner in the same manner. Repeat this process for the remaining posts and runner.

RUTLAND PANEL PERGOLA

Step 5

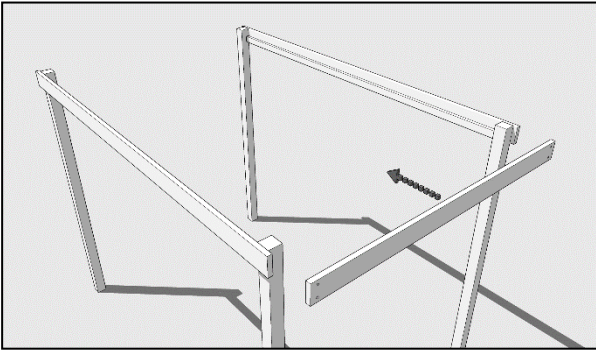

Using your assistants, manoeuvre the previously assembled runner/post assemblies into place, positioning them opposite each other, approximately the length of a rafter apart. Now place one of the outer rafters, the batten toward the bottom of the rafter and on the inner face, across the top of the posts as shown.

Step 6

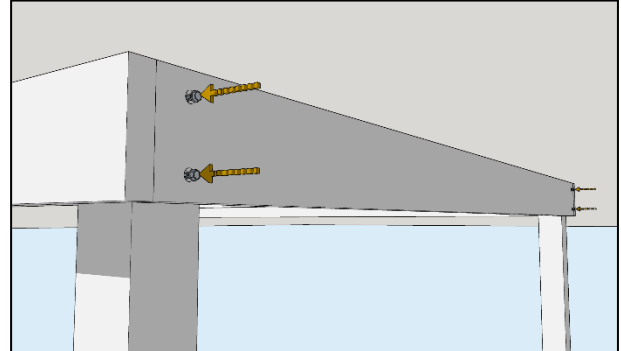

Now secure into place with 2 x 70mm coachscrews into each post.

Step 7

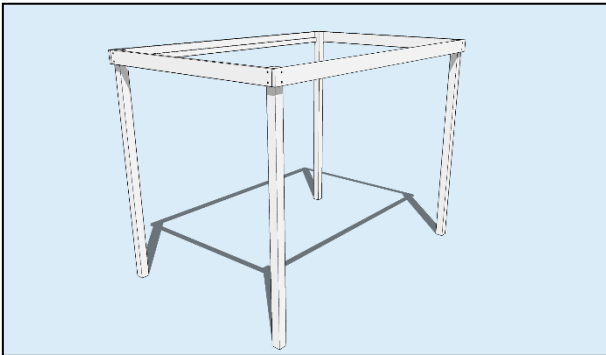

Fix the second outer rafter into place in the same way as before.

Step 8

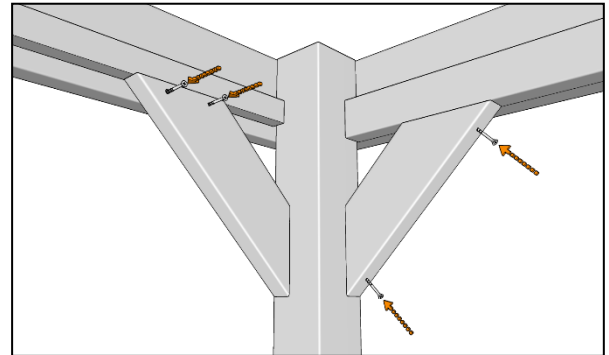

If you have ordered the optional braces for each corner post, add them now. The longer one fits onto the runner (smaller batten) and the shorter one onto the rafter (larger batten) as shown here.

RUTLAND PANEL PERGOLA

Step 9

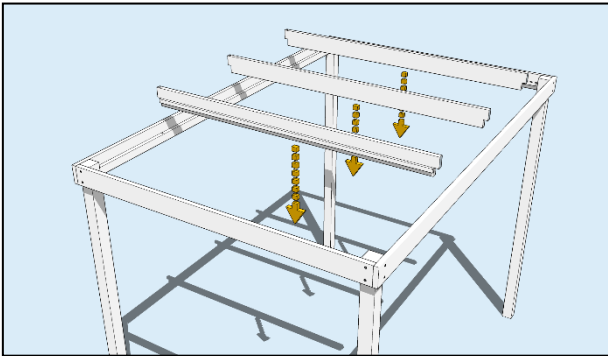

Now drop the rafters into place using the markings on the runner's battens to align them. The two outer rafters should have their battens facing the adjacent outer rafter and the centre rafter(s) will have no batten.

Step 10

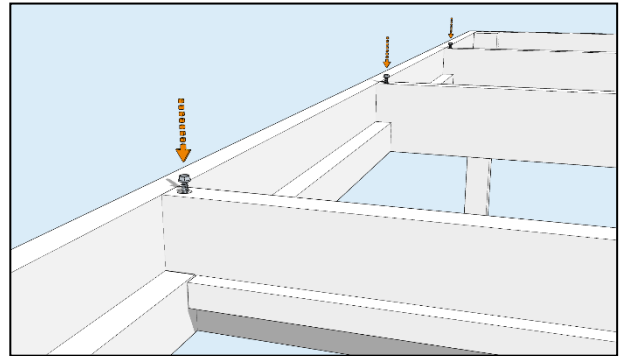

Fix each rafter into place with a 120mm coachscrew driven down through each end as shown.

Step 11

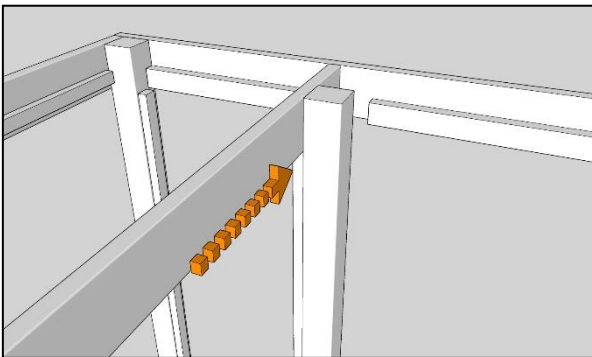

Locate the intermediate post against the runner and inner rafter and secure into place with 2 of the 70mm coachscrews through the runner as you did with the previous posts. Repeat for the remaining post.

Step 12

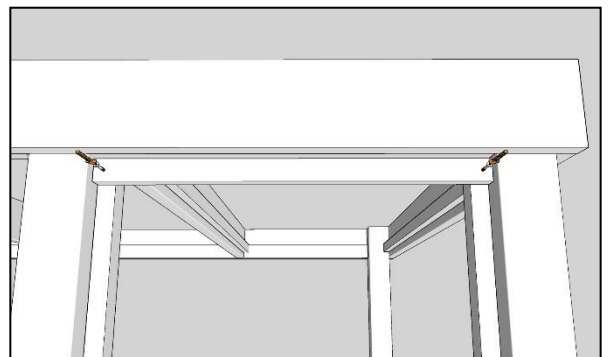

Starting from the top of the battened posts, align a short lattice strip so that it is parallel with the underside of the runner. Fix into place against the battens with a 50mm screw at each end.

RUTLAND PANEL PERGOLA

Step 13



Using the spacer bar, with the wider face against the batten and butted up against the lower faced of the top lattice strip, slide the next lattice strip up against the spacer bar and fix into place against the battens with a 50mm screw at each end. Repeat this process working your way down to create the lattice...

Step 14

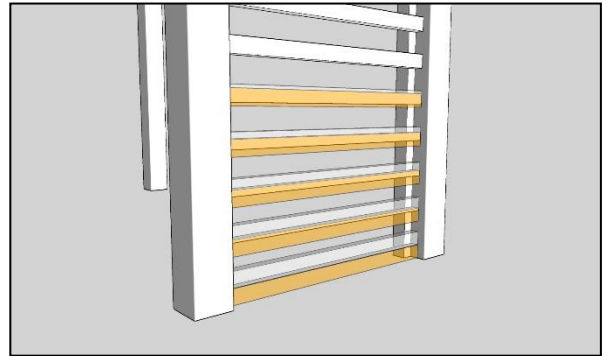

...as you approach the last 5 battens you can either continue using the spacer or alternatively space these by eye so that the final lattice strip finishes at ground level. Repeat Steps 11 - 13 on the other side of the pergola.

Step 15

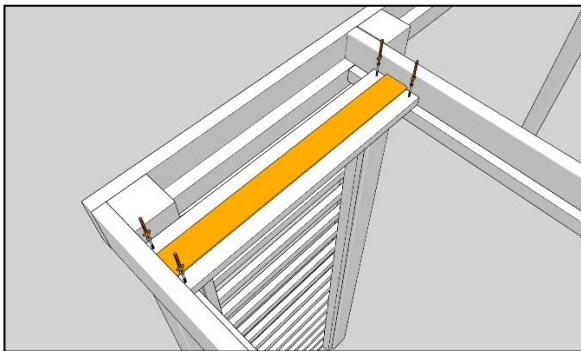

Use the same principle as outlined in steps 12-13 to create the roof lattices.

Step 16

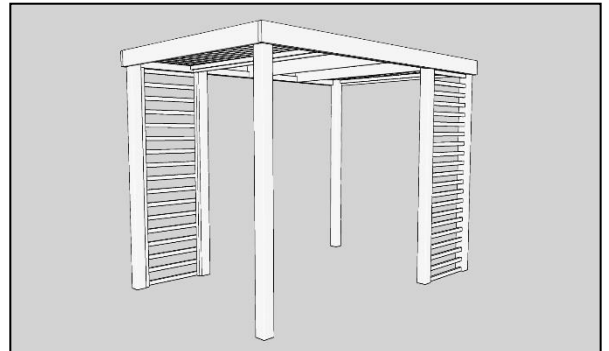

Your Rutland Panel Pergola is now complete.

WE HOPE THAT YOU FOUND YOUR PRODUCT QUICK AND EASY TO ASSEMBLE BUT IF NOT AND YOU REQUIRE ANY FURTHER ASSISTANCE OR HAVE ANY QUESTIONS YOU CAN CONTACT US BY TELEPHONE ON: 01778 440803

EMAIL: INFO@RUTLANDCOUNTYGARDENFURNITURE.CO.UK

WWW.RUTLANDCOUNTYGARDENFURNITURE.CO.UK

Rutland County Garden Furniture Ltd, Ashbourne House, 2 Dovecote Meadows,
Aslackby, Sleaford, Lincs, NG34 0HZ.
Company No: 11025348 VAT No: 282569762