



RUTLAND COUNTY
GARDEN FURNITURE

Hand-Crafted

ASSEMBLY INSTRUCTIONS

POLYCARBONATE CAR PORT 4 POST (6.5 & 7.2M)

Before you commence the assembly process, we recommend that you read these instructions thoroughly beforehand to familiarise yourself with the assembly process and to also check that you have the correct components. If for any reason you need assistance, you can find our contact details on the final page of these instructions.

We strongly recommend that any assembly is carried out on an open flat, level surface if possible and with sufficient space. You will also require the assistance of at least 2 adults to complete assembly safely.

Tools required:

10mm socket, No2 Pozidriv screwdriver (or electric driver), step ladder or platform.

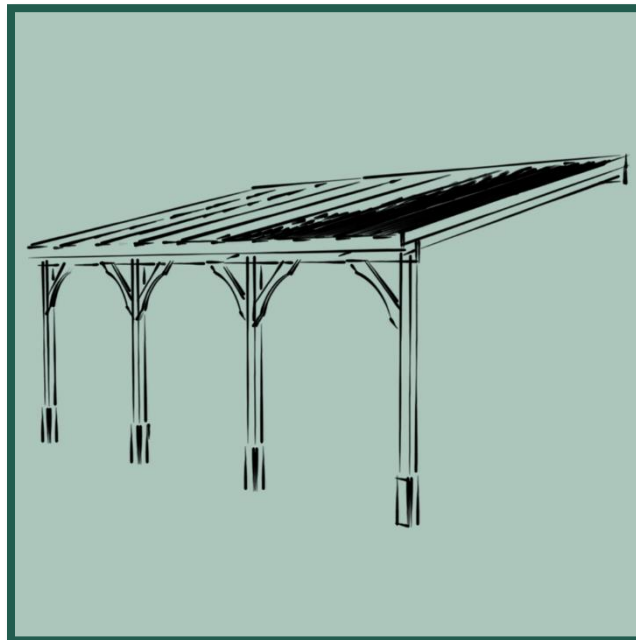

POLYCARBONATE CAR PORT – 4 POST

Product Specification Table









Please use the table below in conjunction with the Components list on page 3 to check you have the correct parts before commencing assembly of your carport.

	2 x 6.5M	2 x 7.2M	2.5 x 6.5M	2.5 x 7.2M	3 x 6.5M	3 x 7.2M	3.5 x 6.5M	3.5 x 7.2M	4.5 x 6.5M	4.5 x 7.2M
40mm Screws	8	8	10	10	12	12	12	12	16	16
60mm screws	142	148	152	159	162	170	162	170	182	192
50mm Coachscrew	4	4	4	4	4	4	4	4	4	4
100mm Coachscrew	14	14	14	14	14	14	14	14	14	14
120mm Coachscrew	20	22	20	22	20	22	20	22	20	22
60mm Roofing Screw	8	8	10	10	12	12	12	12	16	16
Roof panel	9	10	9	10	9	10	9	10	9	10
Glazing bar	8	9	8	9	8	9	8	9	8	9
Glazing bar capping	8	9	8	9	8	9	8	9	8	9
Glazing bar end cap	8	9	8	9	8	9	8	9	8	9
Panel closure strip	9	10	9	10	9	10	9	10	9	10
Posts	4	4	4	4	4	4	4	4	4	4
Wall plate	2	2	2	2	2	2	2	2	2	2
Runner	3	3	3	3	3	3	3	3	3	3
Rafter	10	11	10	11	10	11	10	11	10	11
Brace	6	6	6	6	6	6	6	6	6	6
Rafter brace	2	2	2	2	2	2	2	2	2	2
End cover	2	2	2	2	2	2	2	2	2	2
Fascia	2	2	2	2	2	2	2	2	2	2
Cladding	16	16	16	16	16	16	16	16	16	16

POLYCARBONATE CAR PORT – 4 POST

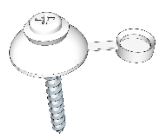
Component list

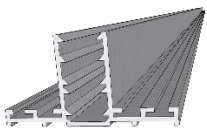
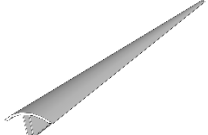
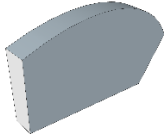
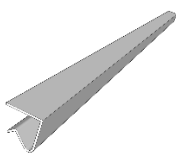
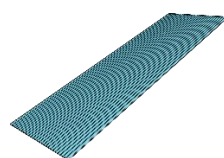
The Product Specification table on page 2 will contain quantities for the components shown below.

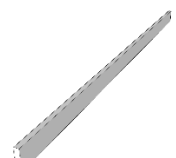
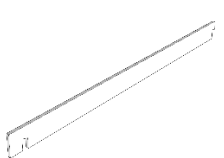
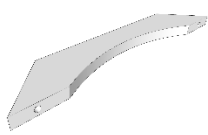
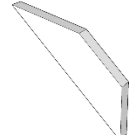
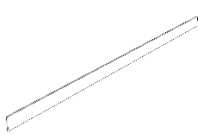
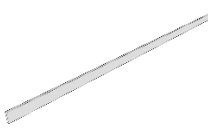
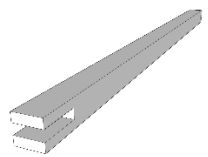
40mm woodscrews	60mm woodscrews	50mm coachscrews	100mm coachscrews	120 mm coachscrews
				
60mm Roofing screws	5mm Drill bit (x1)	Glazing bar	Glazing bar capping	Glazing bar end cap
				
Panel closure strip	Roof panel	Wall plate	Runner	Rafter
				
Brace	End brace	End cover	Fascia	Posts
				

POLYCARBONATE CAR PORT – 4 POST

Panel and glazing bar preparation

Before commencing assembly, the outer panel edges and glazing bars will need to be pre-drilled as per the following instructions using the spacings indicated in the table below.

Panel length table

	Panel length					
	2M	2.5M	3M	3.5M	4M	4.5M
Holes per panel/bar	4	5	6	6	7	8
Hole spacing	600	575	560	660	633	614
Wall plate height - top edge*	2556	2643	2730	2817	2873	2990
Post distance from wall	1764	2256	2748	3240	3733	4225
Top of post to Top of wall plate	310	397	484	571	658	755

* The "Wall plate height – top edge" is a recommendation based upon a default post height of 2240mm. If either the wall plate height or post height is to be adjusted, please use the "Top of post to Top of wall plate", dimension A in the figure below, to calculate the new Wall plate and post heights.

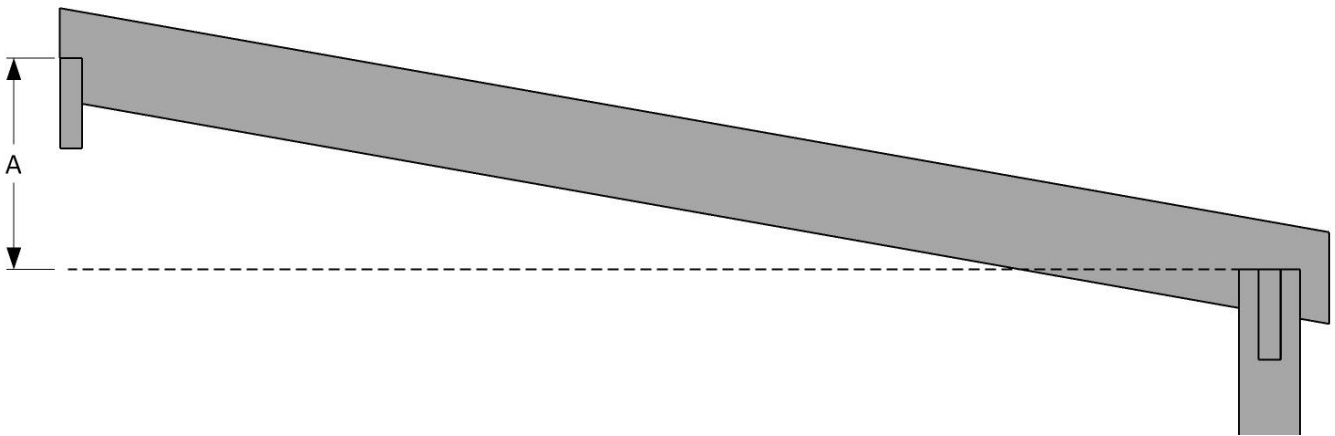

POLYCARBONATE CAR PORT – 4 POST

Glazing bars

Measure 100mm from either end of the glazing bar (fig.1) and using the 5mm drill bit supplied, drill the first hole by using the central groove in the base of the glazing bar as a guide and drilling through as shown (fig. 2). Using the Panel length table, now measure along the glazing bar the appropriate length from the centre point of the first hole and continue to add the remaining holes in the glazing bar in this manner. The final hole should be approximately 100mm from the opposing end of the glazing bar.

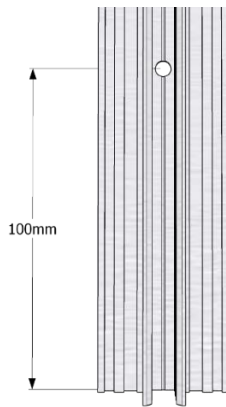

fig.1



fig 2.

Polycarbonate panels

Two of the roof panels will be fitted as a “mirror” pair with holes down one edge to allow them to be fixed to the outer rafters. Lay out 2 panels with the UV coated side uppermost and the aluminium tape on both panels at the same end (fig. 1). Start by placing a piece of scrap timber under the area to be drilled. Now drill the first hole 100mm from either end of one the panels and 17mm from the edge (fig.2) using the 5mm drill bit supplied. Using the Panel length table (page 4), now measure along the panel the appropriate length from the centre point of the first hole, move the scrap timber into position and continue to add the remaining holes, 17mm from the edge of the panel as before. The final hole should be approximately 100mm from the opposing end of the panel. Repeat the drilling process for the second panel, this time drilling the opposing edge as shown (fig 1). We recommend any protective film is not removed until you are ready to install the panel.

POLYCARBONATE CAR PORT – 4 POST

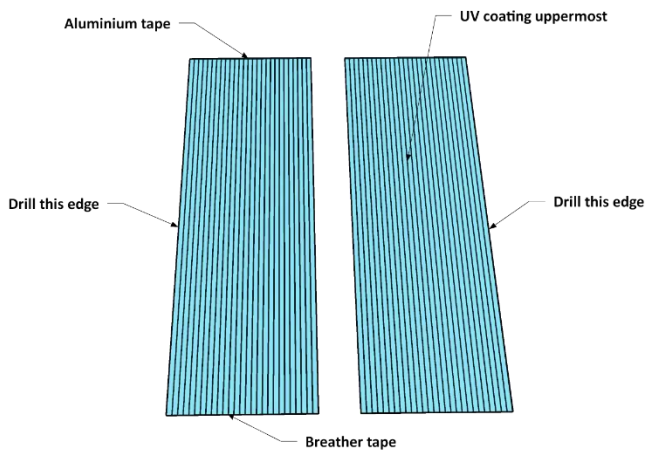

fig.1

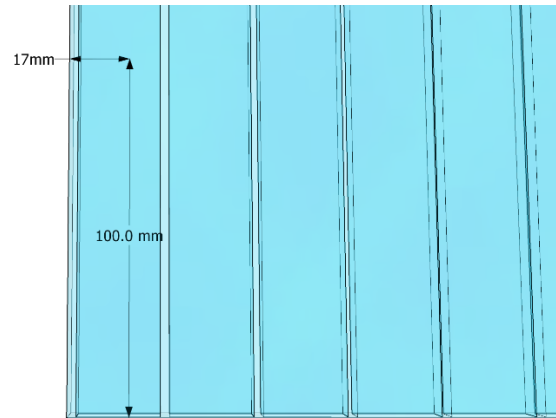
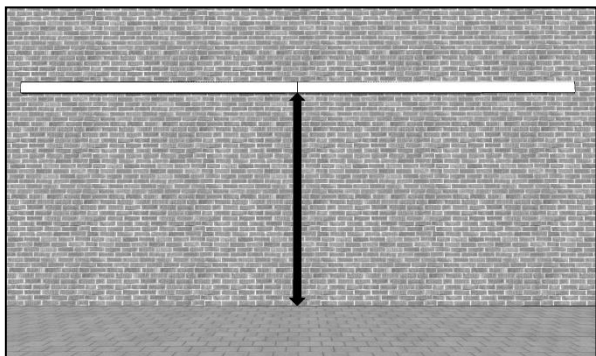

fig.2

POLYCARBONATE CAR PORT – 4 POST

Step 1



Begin by taking the wall plates, one at a time, and placing them horizontally (use a spirit level or laser) on the wall where you would like the car port located. Check the Panel length table (page 4) to establish the distance from TOP of the wall plates to the floor. Mark the hole positions for your wall fixings then drill and fix them into place.

Step 2

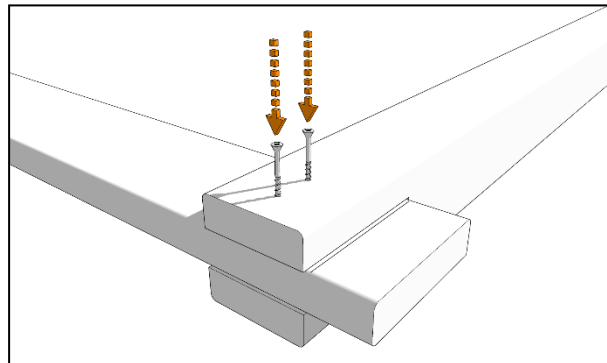

Place one of the posts on a flat surface as shown and then insert one of the longer runners into the post slot, using the markings spaced at 95mm apart on the runner as a guide to align the post. Fix into place with 2 x 60mm woodscrews.

Step 3

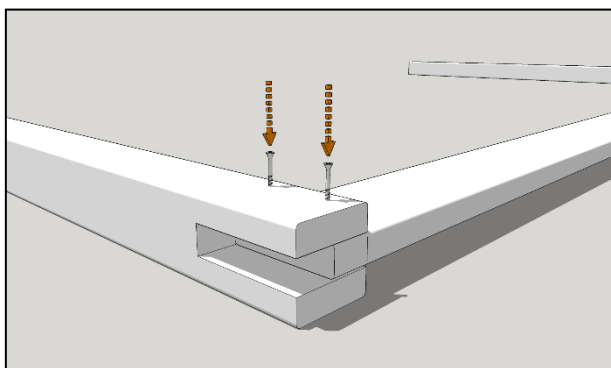

Slot another post over the other end of the runner, aligning with the single mark on the runner top edge and fix into place with 2 x 60mm woodscrews.

Step 4

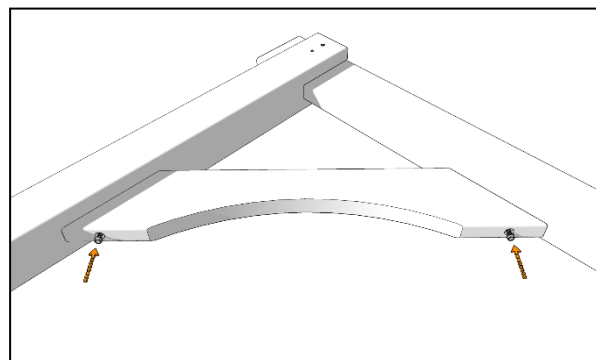

Align a brace with the underside of the runner (at either end) and centrally across the inside face of the post as shown. The mating faces should be flat against each other before fixing the brace into place with a 100mm coachscrew at each end. Repeat and attach the remaining brace to the other end of the runner to form a "goal post" structure.

POLYCARBONATE CAR PORT – 4 POST

Step 5

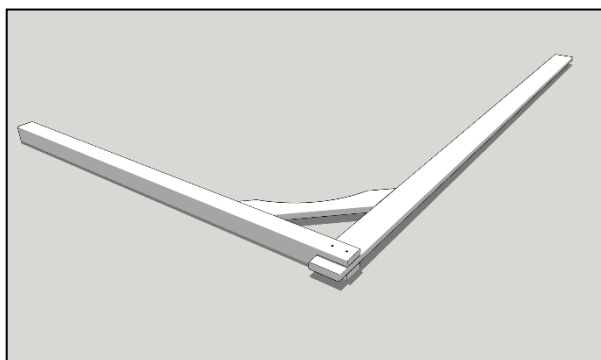

Assemble the remaining “goal post” type structures but with only one post each, using the remaining posts, runners and braces. One with a longer runner and the runner overhanging the post...

Step 6

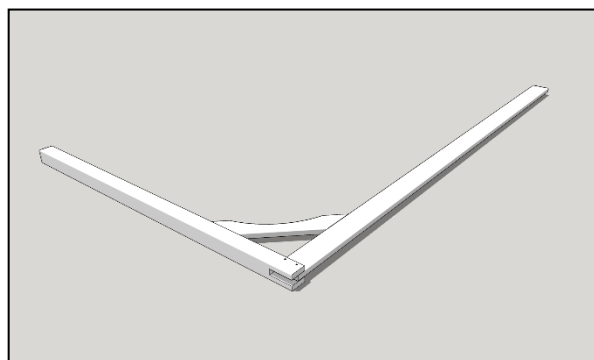

...and the other with the shorter runner and the end housed in the post joint.

Step 7



Using your assistants, manoeuvre the previously assembled “goalpost” with 2 posts into place. Position it parallel to the wall with the outer end post adjacent to end of your of wall plate as shown. Consult the Panel length table (page 4) to correctly distance the posts from the wall.

Step 8

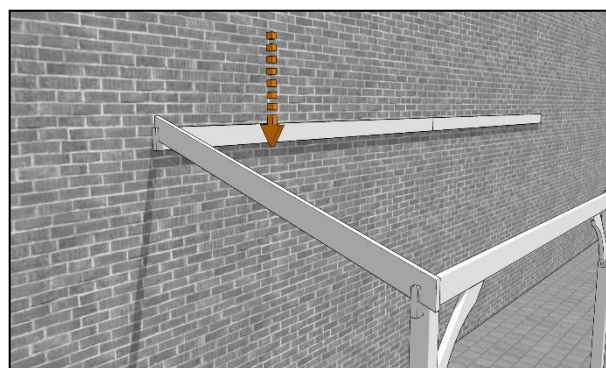

Now drop one of the outer runners into place...

POLYCARBONATE CAR PORT – 4 POST

Step 9

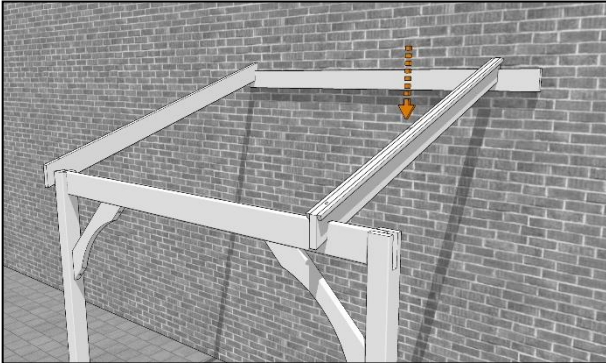

Add an intermediate rafter to the other end of the runner, aligning with the markings and adjusting the position of the “goal post” as necessary. Do not fix in place at this stage.

Step 10

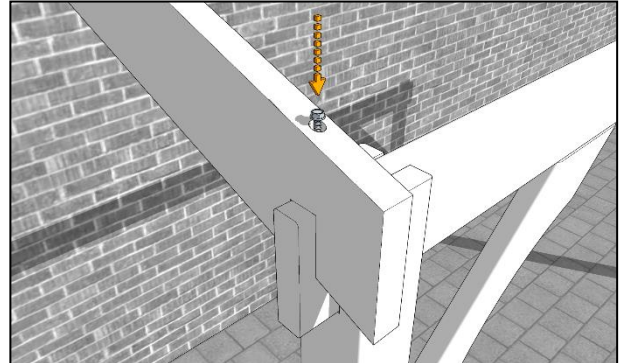

Butt the outer rafter against the outer face of the post before securing in place with a 120mm coachscrew driven down into the runner.

Step 11

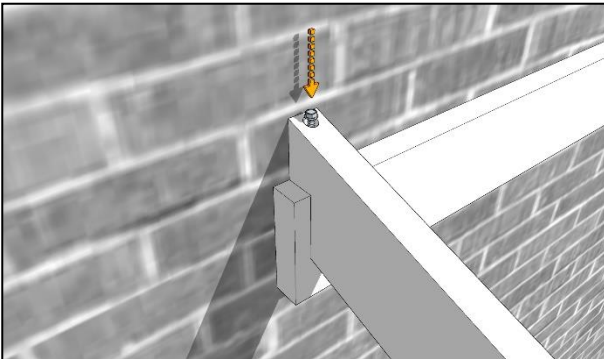

Adjust the positioning of the “goal post” if necessary, so that the notch in the underside of the wall end of the outer rafter sits snugly on the top of the wall plate and also lines up with the markings indicating its correct position. Fix in place with a 120mm coachscrew driven into the runner.

Step 12

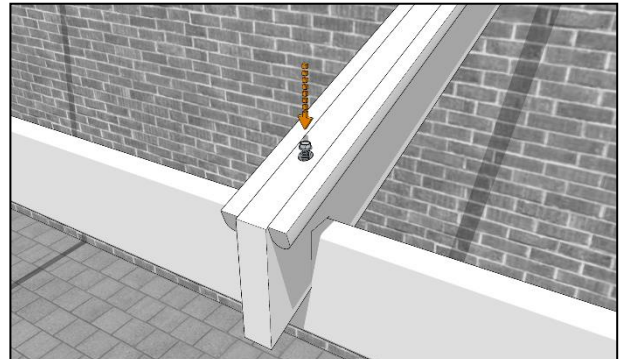

Now fix the rafter into place with 120mm coachscrew into the runner...

POLYCARBONATE CAR PORT – 4 POST

Step 13

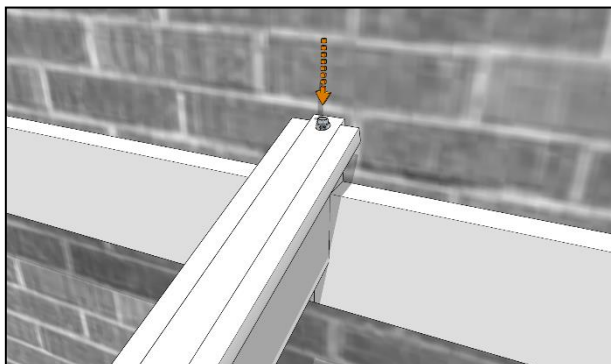

...and another into the wall plate.

Step 14

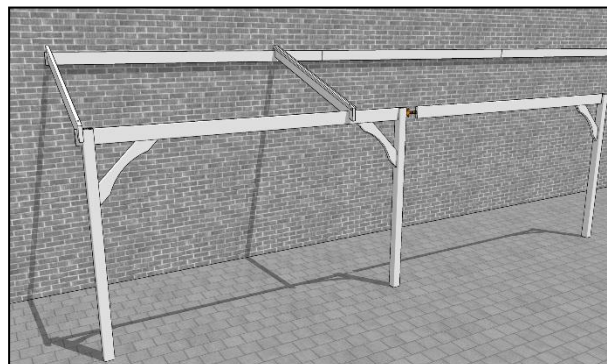

Using your assistants again, manoeuvre the previously assembled "goal post" with shorter runner into place. Slide the free runner end into the slot in the centre post pushing it fully home until it butts against the other runner...

Step 15

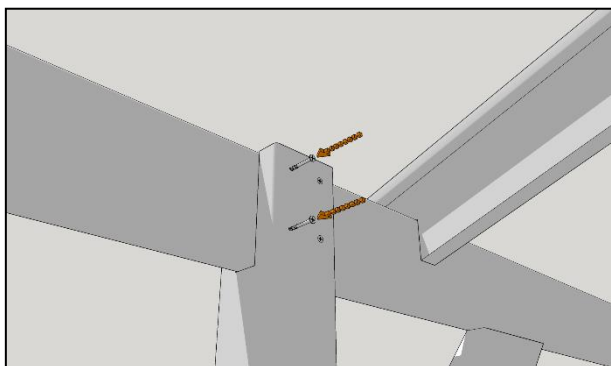

... before securing it into place with 2 x 60mm screws through the post into the runner.

Step 16

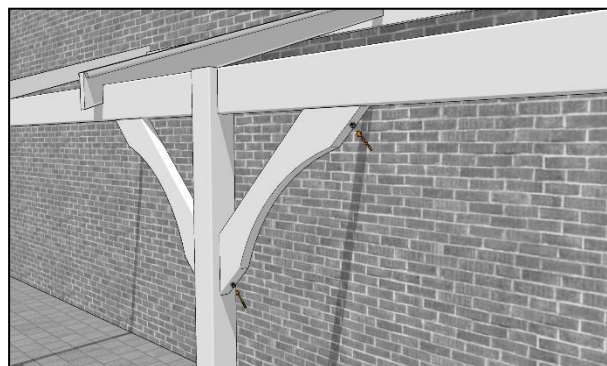

Now fit the next brace into place, Aligning it the underside of the runner and centrally across the inside face of the post. Fix it into place with a 100mm coachscrew at each end.

POLYCARBONATE CAR PORT – 4 POST

Step 17

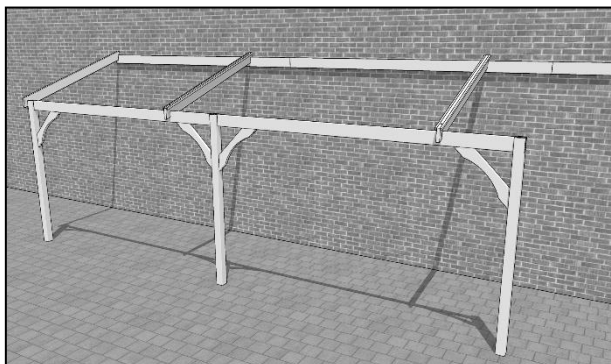

Add another intermediate rafter as before, aligning it with the markings on the wall plate and runner before securing into place with a 120mm coachscrew at each end.

Step 18

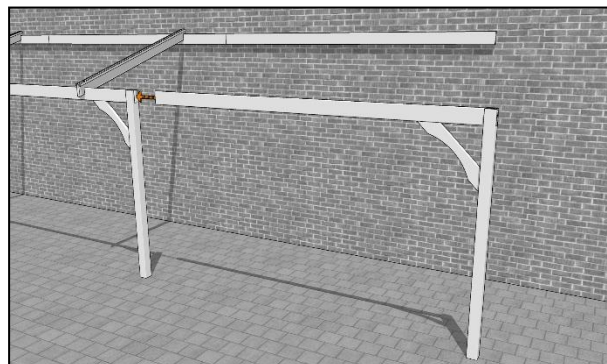

Using your assistants again, manoeuvre the final long runner "goal post" into place. Slide the free runner end into the slot in the intermediate post, pushing it fully home until it butts against the other runner. Repeat steps 15-16 to fix to the post and add the final brace.

Step 21

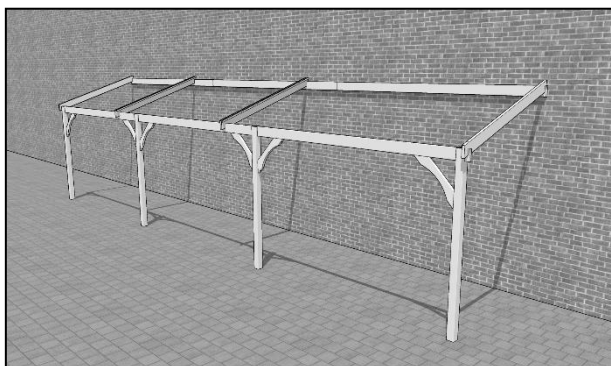

Add the final outer rafter as before in step 8 and secure in place with 2 x 120mm coachscrews as in steps 10 – 11.

Step 22

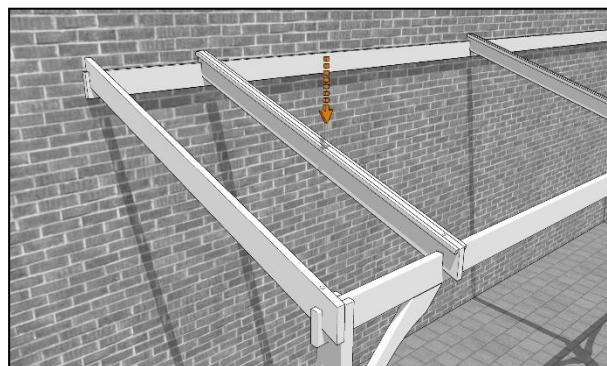

Starting from one end of the structure, add the remaining intermediate rafters, using the markings on the runner and wall plate and securing in place with a 120mm coachscrew at each end as you go...

POLYCARBONATE CAR PORT – 4 POST

Step 23

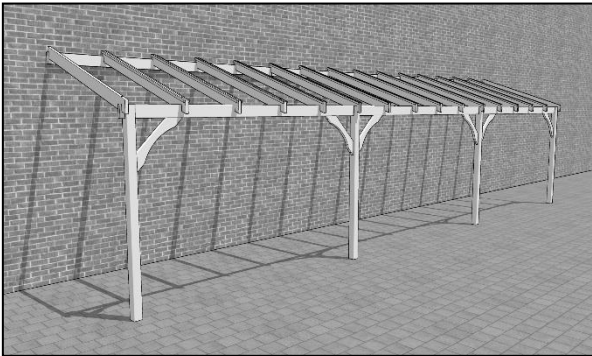

...until all of the rafters are fitted.

Step 24

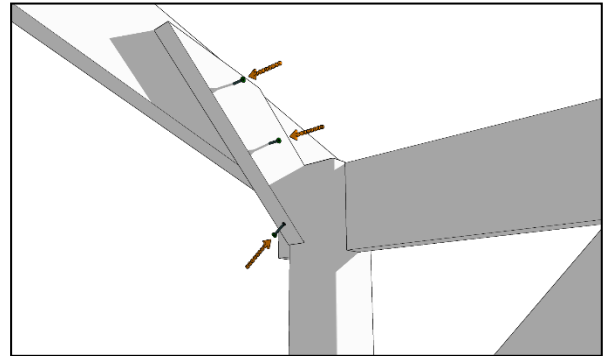

Place an end brace against the inner face of the outer runner so that the lower face is butted against the inner face of the post and the top edge is approximately 10mm from the top edge of the rafter. Fix in place with 2 x 50mm coachscrews into the rafter and 1 x 100mm coachscrew into the post as shown. Repeat for the other end of the structure.

Step 25

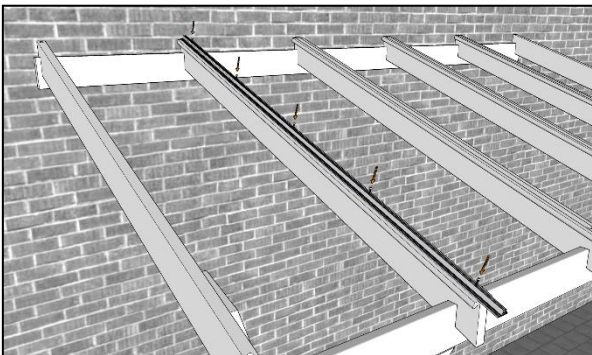

Starting from one end of the car port, attach the previously drilled glazing bar so that it is centred on the first inner rafter and butted up to the wall as shown. Fix in place with 60mm screws.

Step 26

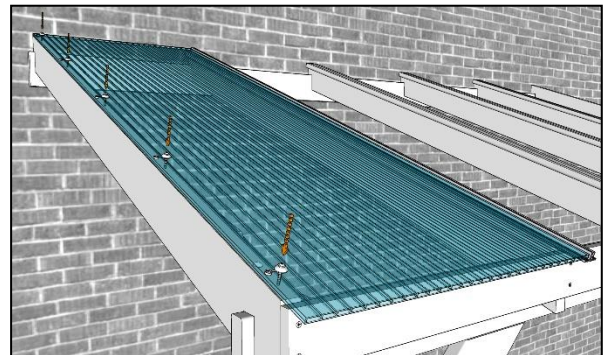

Position one of the drilled polycarbonate panels so that it sits on the glazing bar, aluminium tape at the wall, UV coated side up and the drilled edge flush with the outer rafter. Ensure the inner edge is parallel with glazing bar and adjust the "goalpost" laterally if necessary before fixing the panel in place with 60mm roofing screws and then closing the cover caps.

POLYCARBONATE CAR PORT – 4 POST

Step 27

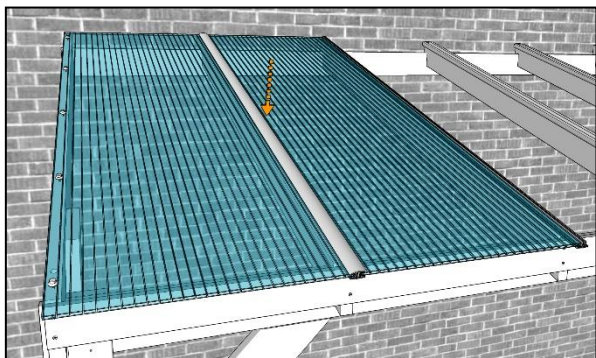

Add the next glazing bar as before, centred on the rafter and butted against the wall. Add an undrilled panel, aluminium tape at the wall and UV coated side up, adjacent to the last panel and use an assistant to support the lower panel edge whilst the glazing bar capping is snapped into place on the first glazing bar as shown.

Step 28

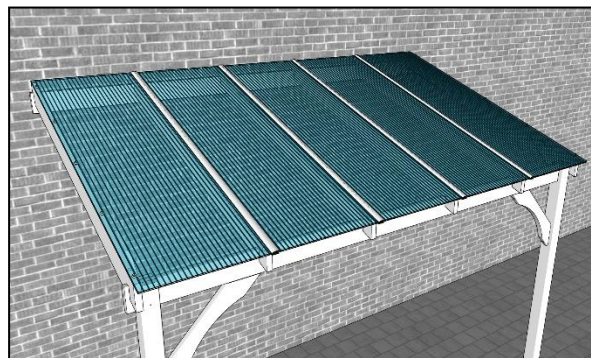

Continue adding further panels and cappings as you did in Step 27 and finish off with the other drilled panel, fixed in place with roofing screws as you did with the first panel in Step 26.

Step 29

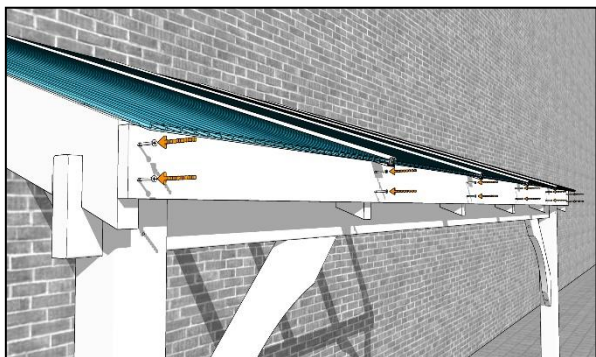

Position a fascia section so that its end is flush with an outer rafter and its top edge is just touching the underside of the glazing bars. Fix into place with a pair of 60mm screws into the rafter ends. Attach the remaining fascia sections by butting them up to the first section and fixing in place in the same manner.

Step 30

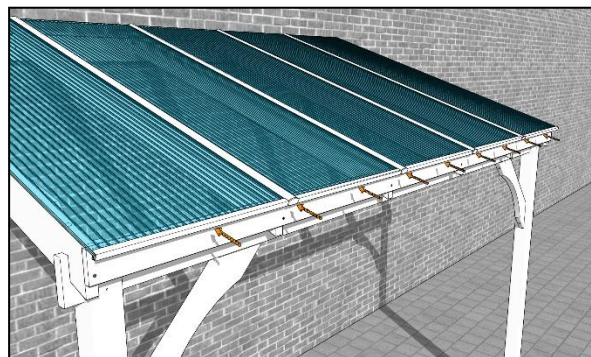

Slot a panel closure strip onto the end of each panel and a glazing bar cap onto the end of each capping.

POLYCARBONATE CAR PORT – 4 POST

Step 31

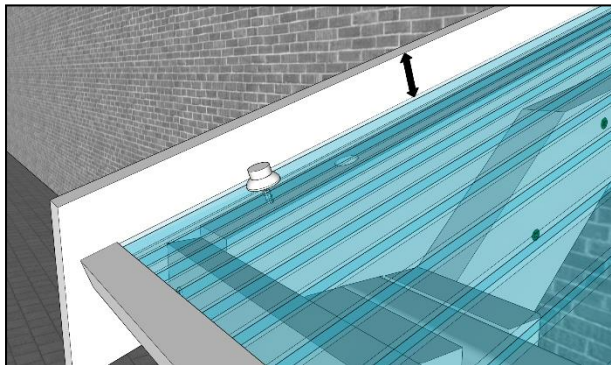

Position the end cover so that its rear edge is butted against the wall and the top edge is 30mm above the roof panel...

Step 32

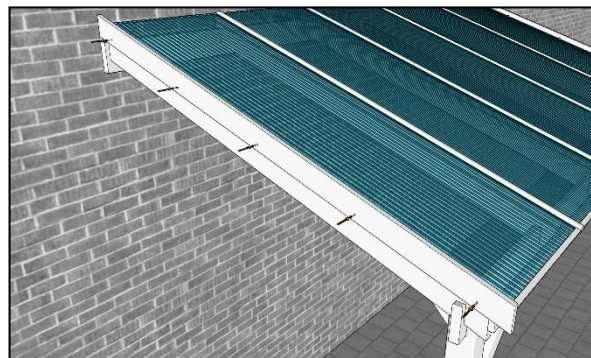

...and fix into place with 40mm screws spaced as per the Panel length table (page 4).

Step 33

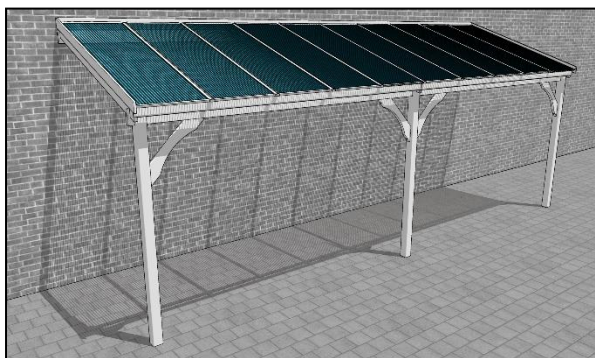

Finish off by applying suitable flashing to the wall/roof join to weatherproof the structure. Your Eternity car port is now complete.

Step 34

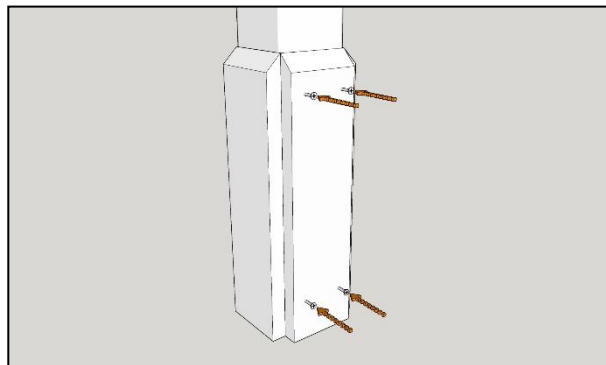

To attach cladding panels simply align as shown at the base of the post before screwing into place using 4 x 60mm woodscrews through the pre-drilled holes per panel. Repeat for each face of the post.

We hope that you found your product quick and easy to assemble but if not and you require any further assistance or have any questions you can contact us by telephone on: **01778 440803**

Email: info@rutlandcountygardenfurniture.co.uk www.rutlandcountygardenfurniture.co.uk