



RUTLAND COUNTY
GARDEN FURNITURE

Hand-Crafted

ASSEMBLY INSTRUCTIONS

POLYCARBONATE CAR PORT 3 POST (5 & 6.5M)

Before you commence the assembly process, we recommend that you read these instructions thoroughly beforehand to familiarise yourself with the assembly process and to also check that you have the correct components. If for any reason you need assistance, you can find our contact details on the final page of these instructions.

We strongly recommend that any assembly is carried out on an open flat, level surface if possible and with sufficient space. You will also require the assistance of at least 2 adults to complete assembly safely.

Tools required:

10mm socket, No2 Pozidriv screwdriver (or electric driver), step ladder or platform.



POLYCARBONATE CAR PORT – 3 POST (5 & 6.5M)

Product Specification Table









Please use the table below in conjunction with the Components list on page 3 to check you have the correct parts before commencing assembly of your carport.

	2 x 5M	2 x 6.5M	2.5 x 5M	2.5 x 6.5M	3 x 5M	3 x 6.5M	3.5 x 5M	3.5 x 6.5M	4.5 x 5M	4.5 x 6.5M
40mm Screws	8	8	10	10	12	12	12	12	16	16
60mm screws	96	108	102	116	108	124	108	124	120	140
50mm Coachscrew	4	4	4	4	4	4	4	4	4	4
100mm Coachscrew	14	14	14	14	14	14	14	14	14	14
120mm Coachscrew	16	20	16	20	16	20	16	20	16	20
60mm Roofing screw	8	8	10	10	12	12	12	12	16	16
Roof panel	7	9	7	9	7	9	7	9	7	9
Glazing bar	6	8	6	8	6	8	6	8	6	8
Glazing bar capping	6	8	6	8	6	8	6	8	6	8
Glazing bar end cap	6	8	6	8	6	8	6	8	6	8
Panel closure strip	7	9	7	9	7	9	7	9	7	9
Posts	3	3	3	3	3	3	3	3	3	3
Wall plate	2	2	2	2	2	2	2	2	2	2
Runner	2	2	2	2	2	2	2	2	2	2
Rafter	8	10	8	10	8	10	8	10	8	10
Brace	4	4	4	4	4	4	4	4	4	4
End brace	2	2	2	2	2	2	2	2	2	2
End cover	2	2	2	2	2	2	2	2	2	2
Fascia	2	2	2	2	2	2	2	2	2	2
Cladding	12	12	12	12	12	12	12	12	12	12

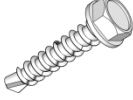
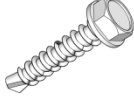
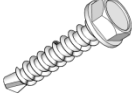
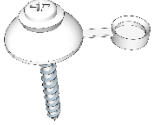
POLYCARBONATE CAR PORT – 3 POST (5 & 6.4M)

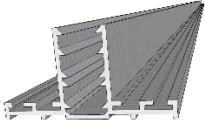
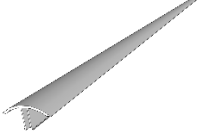
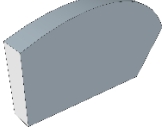
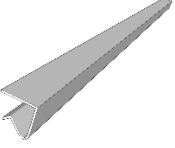
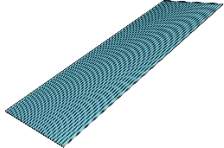
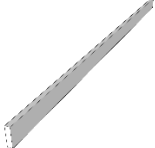
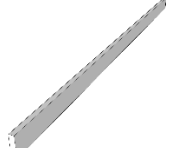
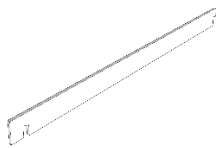
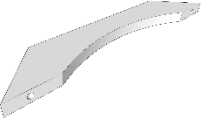
Component list

The Product Specification table on page 2 will contain quantities for the components shown below.

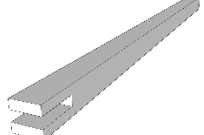
40mm woodscrews	60mm woodscrews	50mm coachscrews	100mm coachscrews	120 mm coachscrews
				
60mm Roofing screws	5mm Drill bit (x1)	Glazing bar	Glazing bar capping	Glazing bar end cap
				
Panel closure strip	Roof panel	Wall plate	Runner	Rafter
				
Brace	End brace	End cover	Fascia	Posts
				

POLYCARBONATE CAR PORT – 3 POST (5 & 6.4M)

Panel and glazing bar preparation

Before commencing assembly, the outer panel edges and glazing bars will need to be pre-drilled as per the following instructions using the spacings indicated in the table below.

Panel length table (all dimensions in mm)

	Panel length					
	2M	2.5M	3M	3.5M	4M	4.5M
Holes per panel/bar	4	5	6	6	7	8
Hole spacing	600	575	560	660	633	614
Wall plate height - top edge*	2556	2643	2730	2817	2873	2990
Post distance from wall	1764	2256	2748	3240	3733	4225
Top of post to Top of wall plate	310	397	484	571	658	755

* The "Wall plate height – top edge" is a recommendation based upon a default post height of 2240mm. If either the wall plate height or post height is to be adjusted, please use the "Top of post to Top of wall plate", dimension A in the figure below, to calculate the new Wall plate and post heights.

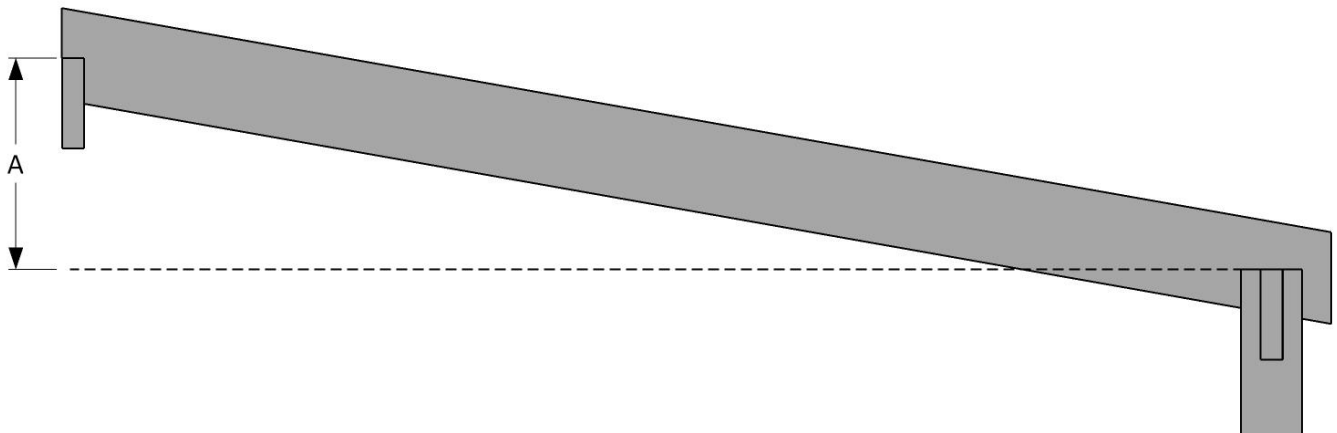

POLYCARBONATE CAR PORT – 3 POST (5 & 6.4M)

Glazing bars

Measure 100mm from either end of the glazing bar (fig.1) and using the 5mm drill bit supplied, drill the first hole by using the central groove in the base of the glazing bar as a guide and drilling through as shown (fig. 2). Using the Panel length table, now measure along the glazing bar the appropriate length from the centre point of the first hole and continue to add the remaining holes in the glazing bar in this manner. The final hole should be approximately 100mm from the opposing end of the glazing bar.

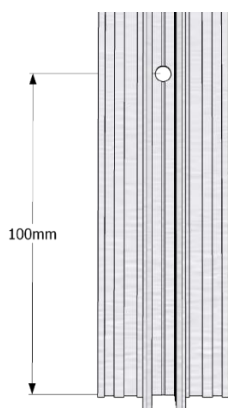

fig.1

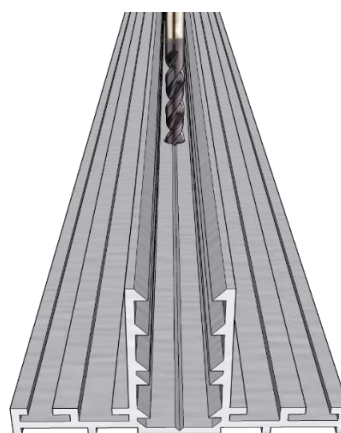

fig 2.

Polycarbonate panels

Two of the roof panels will be fitted as a “mirror” pair with holes down one edge to allow them to be fixed to the outer rafters. Lay out 2 panels with the UV coated side uppermost and the aluminium tape on both panels at the same end (fig. 1). Start by placing a piece of scrap timber under the area to be drilled. Now drill the first hole 100mm from either end of one the panels and 17mm from the edge (fig.2) using the 5mm drill bit supplied. Using the Panel length table (page 4), now measure along the panel the appropriate length from the centre point of the first hole, move the scrap timber into position and continue to add the remaining holes, 17mm from the edge of the panel as before. The final hole should be approximately 100mm from the opposing end of the panel. Repeat the drilling process for the second panel, this time drilling the opposing edge as shown (fig 1). We recommend any protective film is not removed until you are ready to install the panel.

POLYCARBONATE CAR PORT – 3 POST (5 & 6.4M)

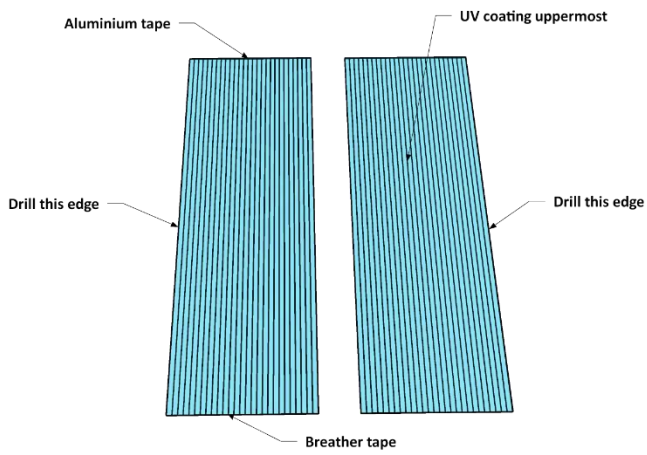

fig.1

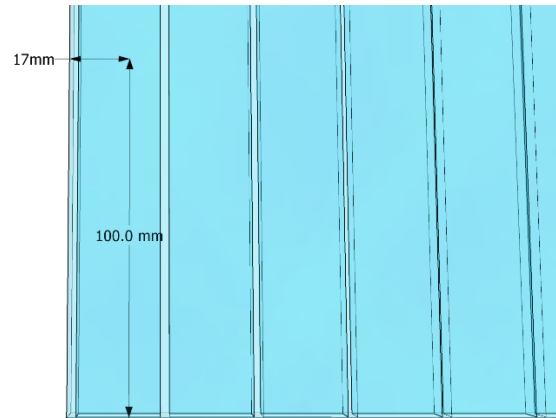
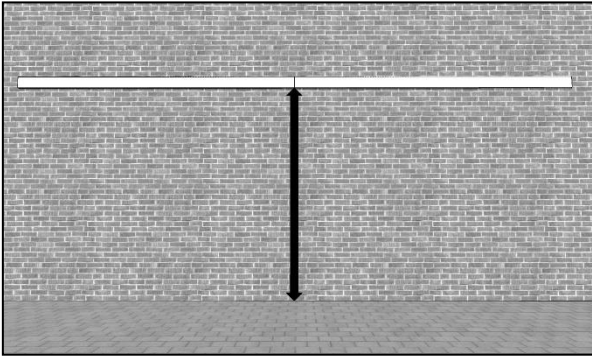

fig.2

POLYCARBONATE CAR PORT – 3 POST (5 & 6.4M)

Step 1



Begin by taking the wall plates, one at a time, and placing them horizontally (use a spirit level or laser) on the wall where you would like the car port located. Check the Panel length table (page 4) to establish the distance from TOP of the wall plates to the floor. Mark the hole positions for your wall fixings then drill and fix them into place.

Step 2

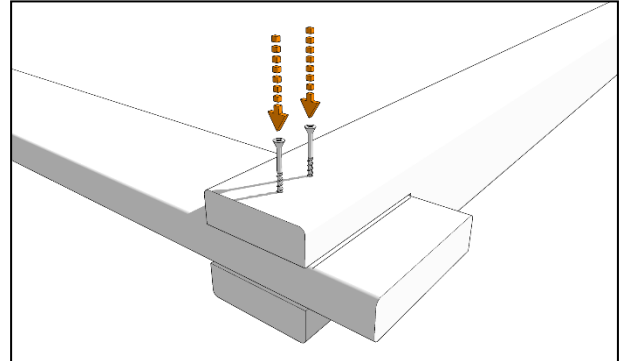

Place one of the posts on a flat surface as shown and then insert one of the runners into the post slot, using the markings on the runner as a guide. Fix into place with 2 x 60mm woodscrews.

Step 3

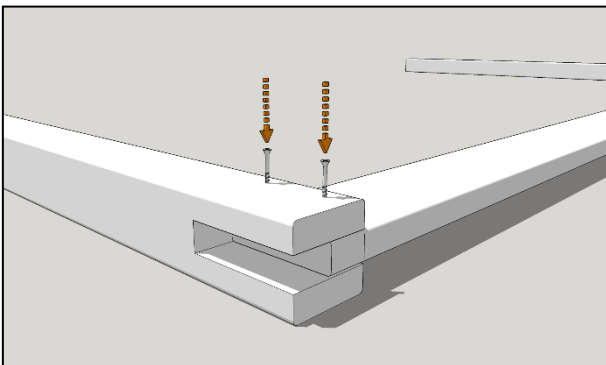

Slot another post over the other end of the runner, aligning with the single mark on the runner top edge and fix into place with 2 x 60mm woodscrews.

Step 4

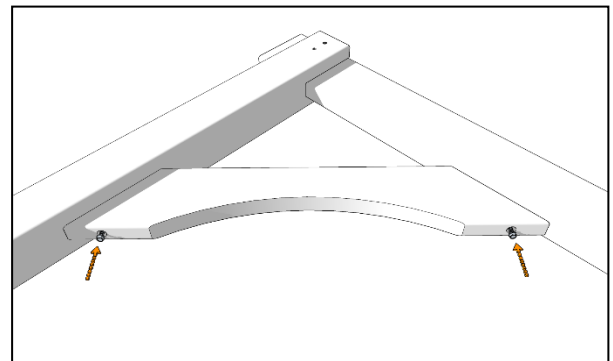

Align a brace with the underside of either end of the runner and centrally across the inside face of the post as shown. The mating faces should be flat against each other before fixing the brace into place with a 100mm coachscrew at each end. Repeat and attach the remaining brace to the other end of the runner to form a "goal post" structure.

POLYCARBONATE CAR PORT – 3 POST (5 & 6.4M)

Step 5

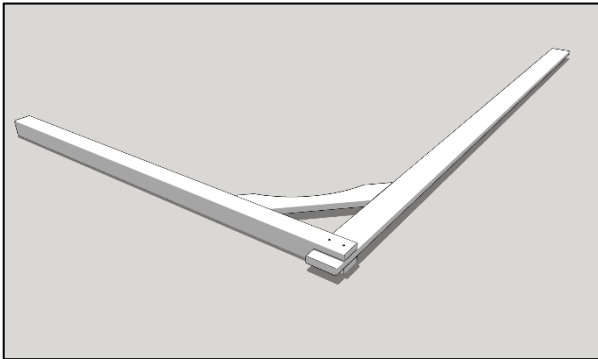

Assemble the second “goal post” using the remaining post, runner and brace in the same manner as before.

Step 6



Using your assistants, manoeuvre the previously assembled “goalpost” with 2 posts into place. Position it parallel to the wall with the runner overhang adjacent to the outer end of your wall plates. Consult the Panel length table (page 4) to correctly distance the posts from the wall.

Step 7

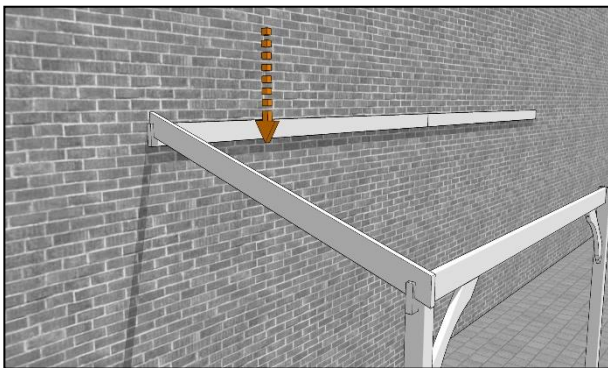

Now drop one of the rafters into place...

Step 8

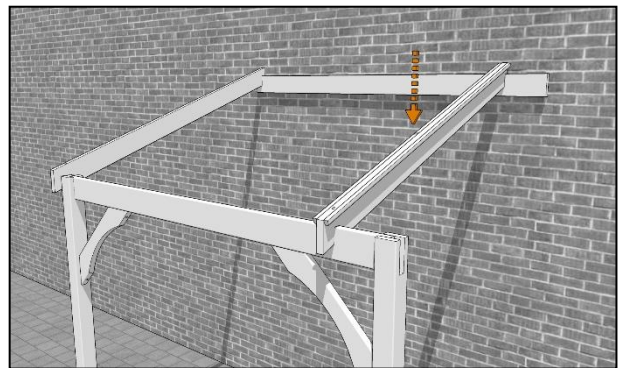

Add a rafter to the slot in the other end of the runner, adjusting the position of the “goal post” as necessary. Do not fix in place at this stage.

POLYCARBONATE CAR PORT – 3 POST (5 & 6.4M)

Step 9

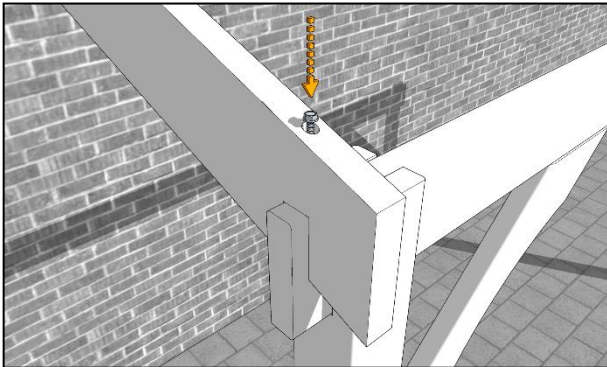

Butt the other rafter against the outer face of the post before securing in place with a 120mm coachscrew driven down into the runner.

Step 10

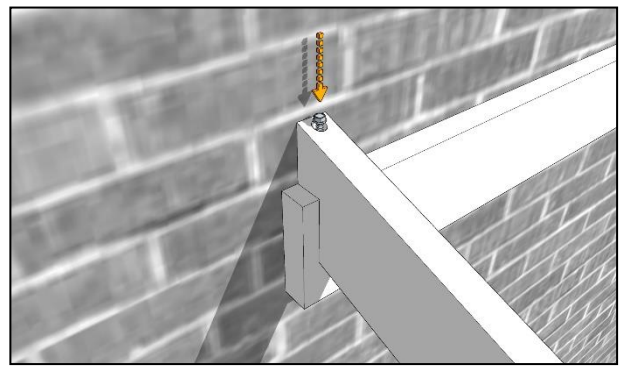

Adjust the positioning of the “goal post” if necessary, so that the notch in the underside of the wall end of the outer rafter sits snugly on the top of the wall plate and also lines up with the markings indicating its correct position. Fix in place with a 120mm coachscrew driven down into the wall plate.

Step 11

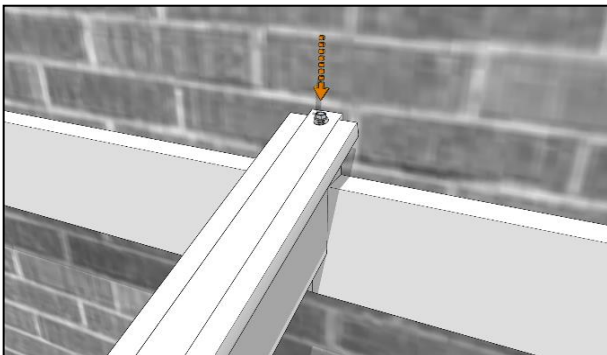

Now fix the intermediate rafter into place with a 120mm coachscrew driven down into the wall plate...

Step 12

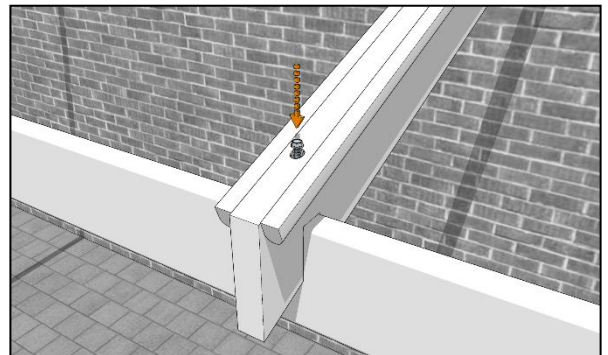

...and another down into the runner.

POLYCARBONATE CAR PORT – 3 POST (5 & 6.4M)

Step 13

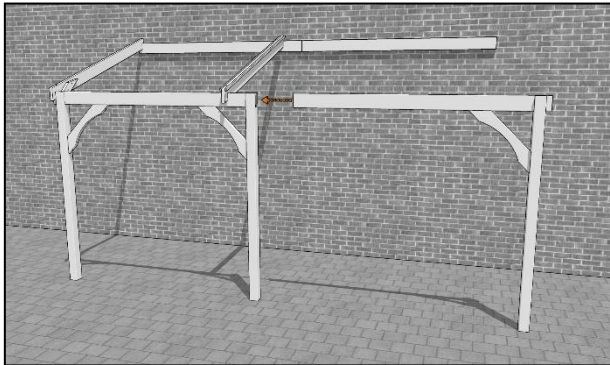

Using your assistants again, manoeuvre the previously assembled "goal post" with 1 post into place. Slide the free runner end into the slot in the centre post pushing it fully home until it butts against the other runner...

Step 14

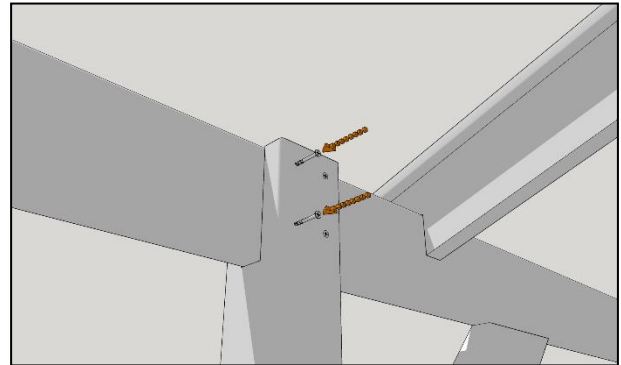

... before securing it into place with 2 x 60mm screws through the post into the runner.

Step 15

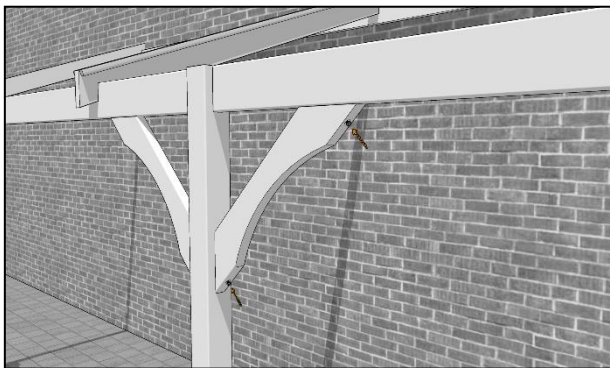

Now fit the final brace into place, Aligning it the underside of the runner and centrally across the inside face of the post. Fix it into place with a 100mm coachscrew at each end.

Step 16

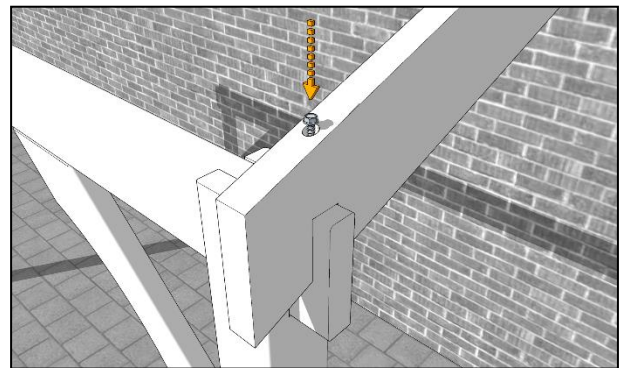

Drop the remaining outer rafter into place and fix into place as you did in steps 9 & 10.

POLYCARBONATE CAR PORT – 3 POST (5 & 6.4M)

Step 17

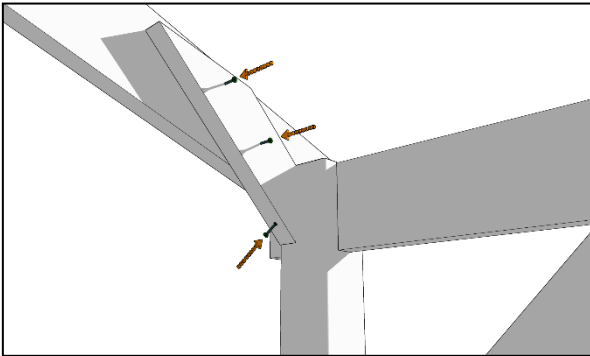

Place an end brace against the inner face of the outer runner so that the lower face is butted against the inner face of the post and the top edge is approximately 10mm from the top edge of the rafter. Fix in place with 2 x 50mm coachscrews into the rafter and 1 x 100mm coachscrew into the post as shown.

Step 18

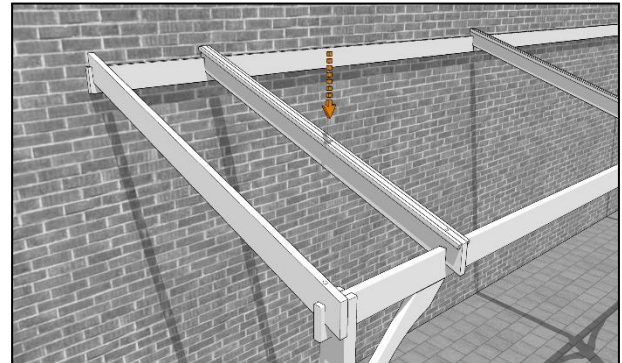

Now add the remaining intermediate runners, using the markings on the runner and wall plate and fixing into place with a 120mm coachscrew into the wall plate and runner as before.

Step 21

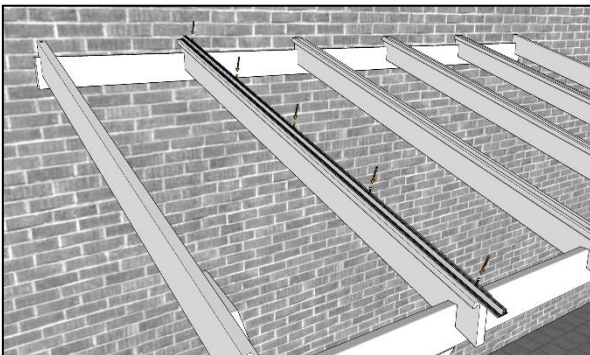

Starting from one end of the car port attach the previously drilled glazing bar so that it is centred on the first inner rafter and butted up to the wall as shown. Fix in place with 60mm screws.

Step 22

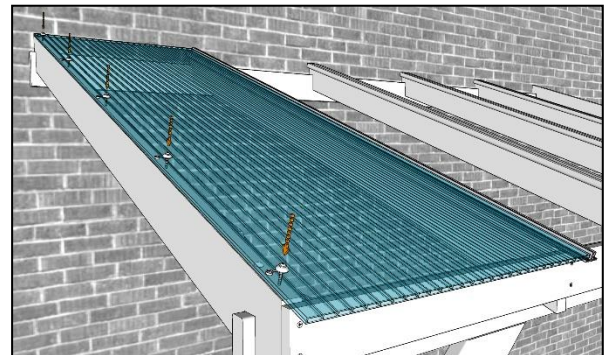

Position one of the drilled polycarbonate panels so that it sits on the glazing bar, aluminium tape at the wall, UV coated side up and the drilled edge flush with the outer rafter. Ensure the inner edge is parallel with glazing bar and adjust the "goalpost" laterally if necessary before fixing the panel in place with 60mm roofing screws and then closing the cover caps.

POLYCARBONATE CAR PORT – 3 POST (5 & 6.4M)

Step 23

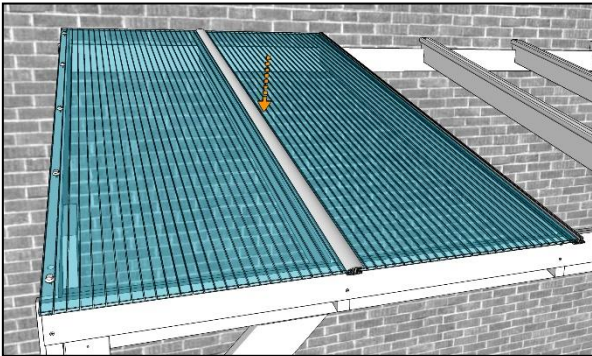

Add the next glazing bar as before, centred on the rafter and butted against the wall. Add an undrilled panel, aluminium tape at the wall and UV coated side up, adjacent to the last panel and use an assistant to support the lower panel edge whilst the glazing bar capping is snapped into place on the first glazing bar as shown.

Step 24

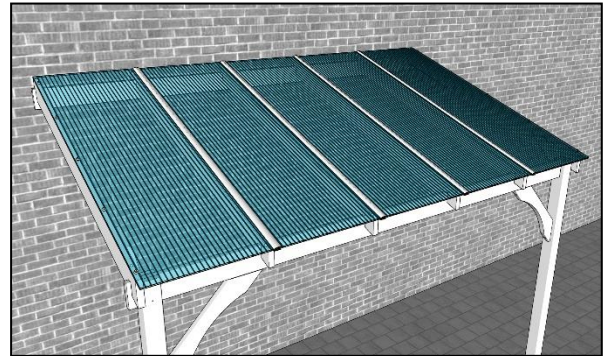

Continue adding further panels as you did in Step 23 and finish off with the other drilled panel, fixed in place with roofing screws as you did with the first panel in Step 22.

Step 25

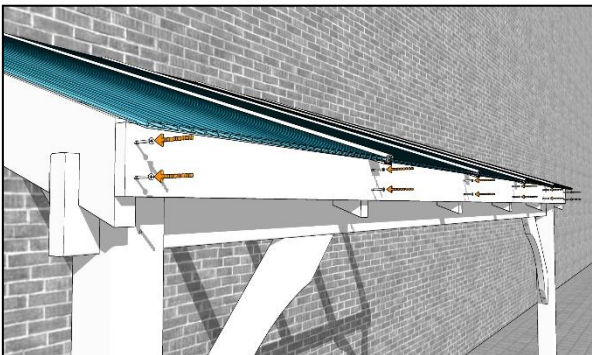

Position the fascia so that its ends are flush with outer rafters and its top edge is just touching the underside of the glazing bars. Fix into place with a pair of 60mm screws into the rafter ends.

Step 26

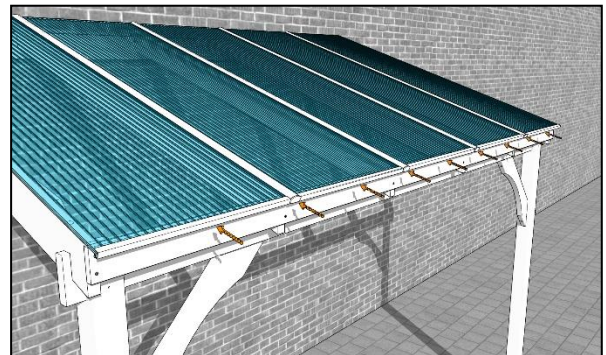

Slot a panel closure strip onto the end of each panel and a glazing bar cap onto the end of each cap.

POLYCARBONATE CAR PORT – 3 POST (5 & 6.4M)

Step 27

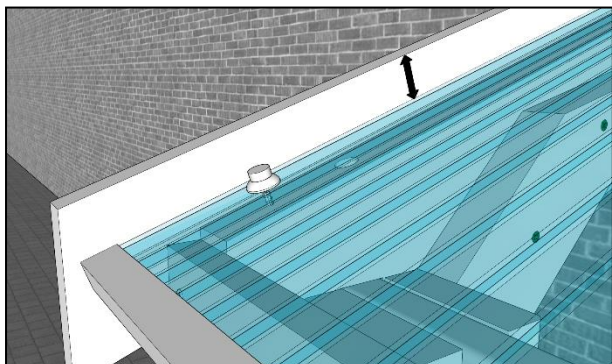

Position the end cover so that its rear edge is butted against the wall and the top edge is 30mm above the roof panel...

Step 28

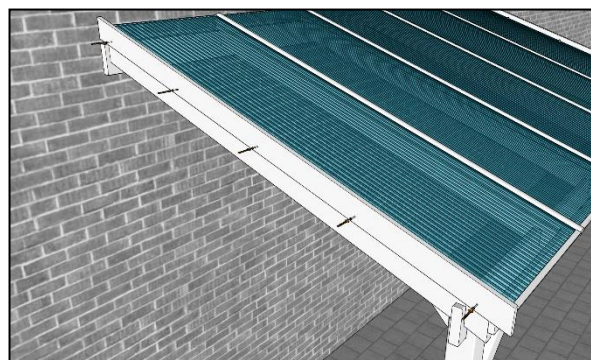

...and fix into place with 40mm screws spaced as per the Panel length table (page 4).

Step 29

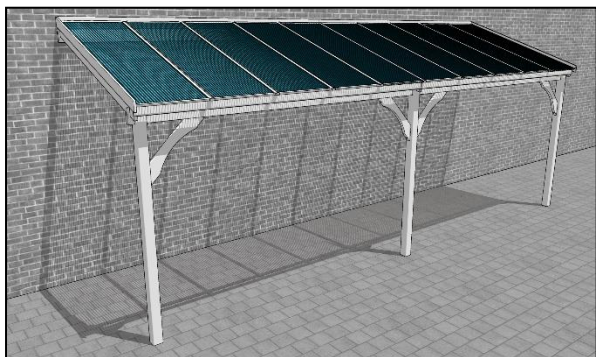

Finish off by applying suitable flashing to the wall/roof join to weatherproof the structure. Your Eternity car port is now complete.

Step 30

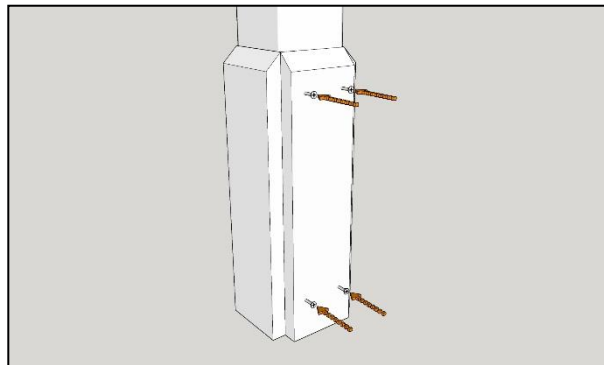

To attach cladding panels simply align as shown at the base of the post before screwing into place using 4 x 60mm woodscrews through the pre-drilled holes per panel. Repeat for each face of the post.

We hope that you found your product quick and easy to assemble but if not and you require any further assistance or have any questions you can contact us by telephone on: **01778 440803**
Email: info@rutlandcountygardenfurniture.co.uk www.rutlandcountygardenfurniture.co.uk